

System Overview



R-Series

TABLE OF CONTENTS

Company Overview	03 - 04
System Overview: SL 38 Tilt & Turn Window	05 - 06
Design Features: SL 38 Tilt & Turn Window	07 - 08
Projects: Sluice Point	09 - 10
SL 38 Window Options	11 - 12
SL 38 Projects	13 - 14
SL 38 Door Options	15 - 16
System Overview: CP 130 Lift & Slide	17 - 18
Design Features: CP 130 Lift & Slide	19 - 20
Projects: A- Frame	21 - 22
CP 130 LS Options	23 - 24
Projects	25 - 26
Projects: Tree Side (Giving Tree) Residence	27 - 28
Projects: Hemlock Point	29 - 30

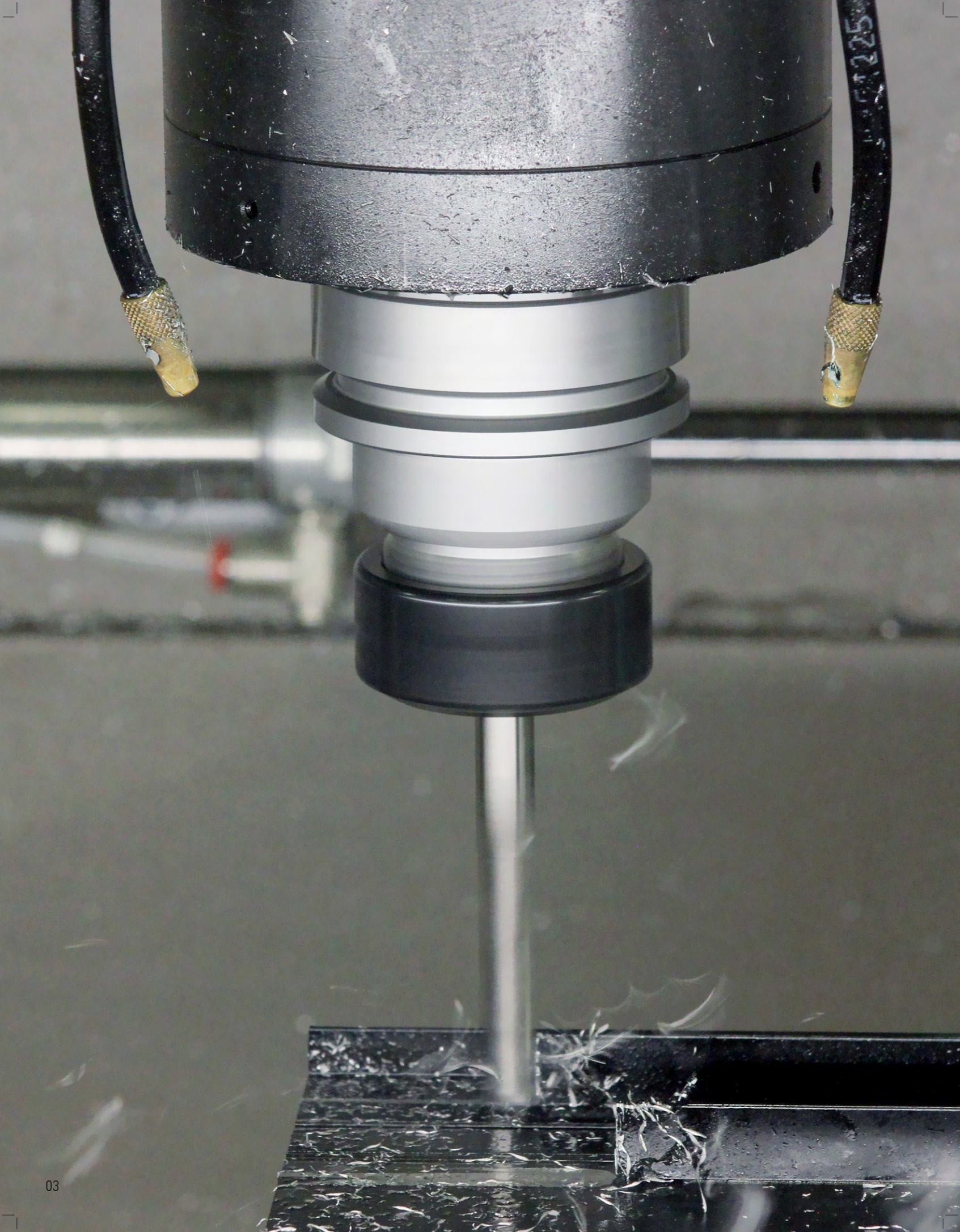

Tiltco provides unparalleled dedication to fabricating exceptional European glazing systems. Working alongside architects, builders, designers and homeowners, Tiltco designs, manufactures and installs prestigious fenestration products. Our superior designs, polished performance and impeccable service, create luxury glazing solutions worthy of the finest residential, commercial and coastal properties.

**FRAME OF
MIND.**

TILTCO ARCHITECTURAL.

SL 38

System Overview: Tilt & Turn Window

Small frame sections combined with cutting-edge energy saving performance: SL 38 is the perfect solution for sustainable design.

The growing importance of energy related matters raise new challenges for architecture. Designers are ever more careful to carry out eco-friendly projects with low energy consumption.

The SL 38 represents a new generation of cutting-edge energy-efficient door and window product. Large polyamide thermal breaks and optional triple glazing enhance the performance while minimal sitemlines create larger glass areas.

The SL 38 product line showcases a 50mm (2") frame sitemline and is available in fixed, tilt and turn, hopper, and coner 90 degree SSG units. The frame strength allows for large format opening and fixed elements allowing freedom of design. Furthermore, various frame and sash designs provide flexibility in architectural styles.

Affiliated Associations:



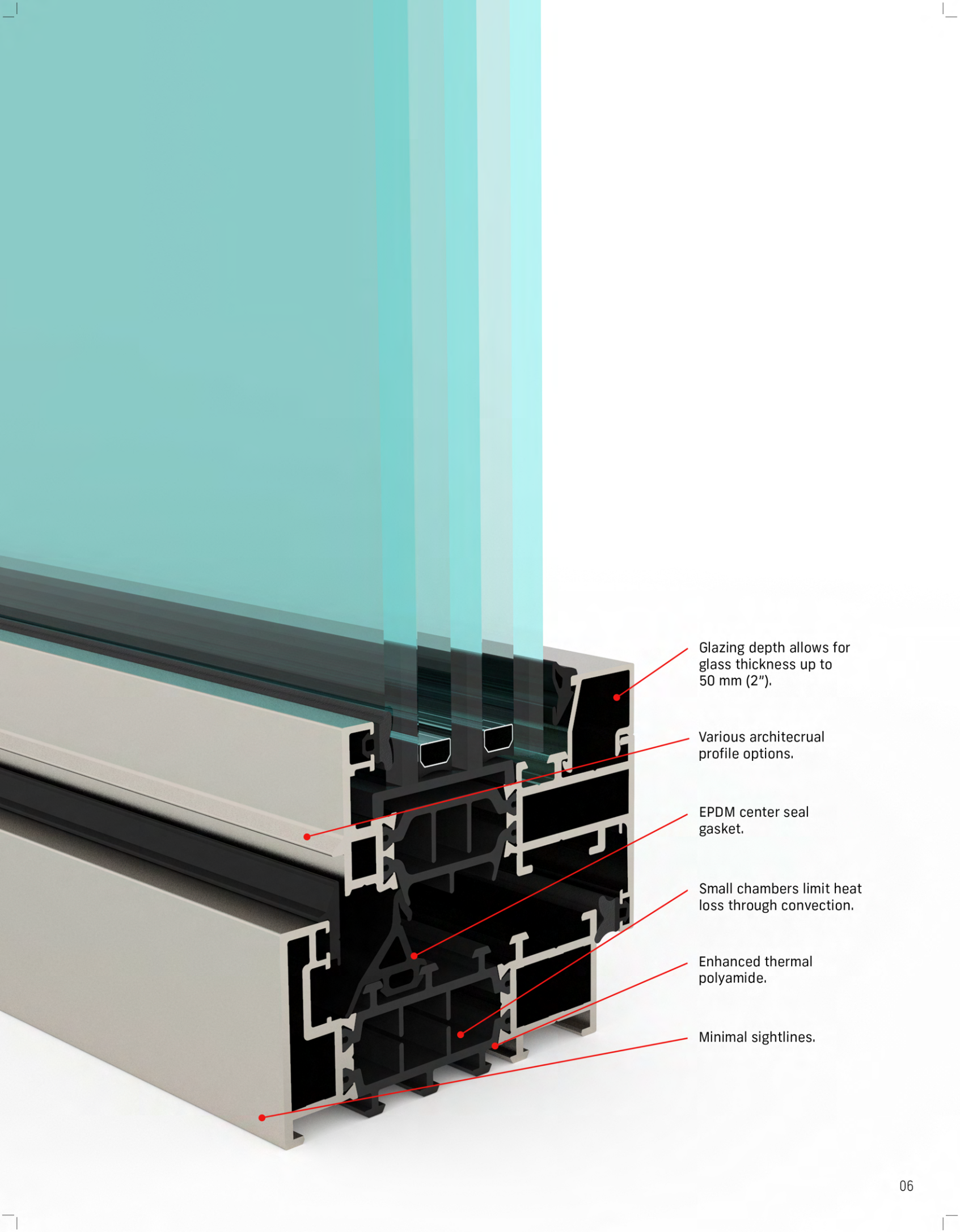

Glazing depth allows for glass thickness up to 50 mm (2").

Various architectural profile options.

EPDM center seal gasket.

Small chambers limit heat loss through convection.

Enhanced thermal polyamide.

Minimal sightlines.

SL 38

Design Features: Tilt & Turn Window

For the architect:
3 frame design options
to adapt to various
architectural details
and aesthetics.

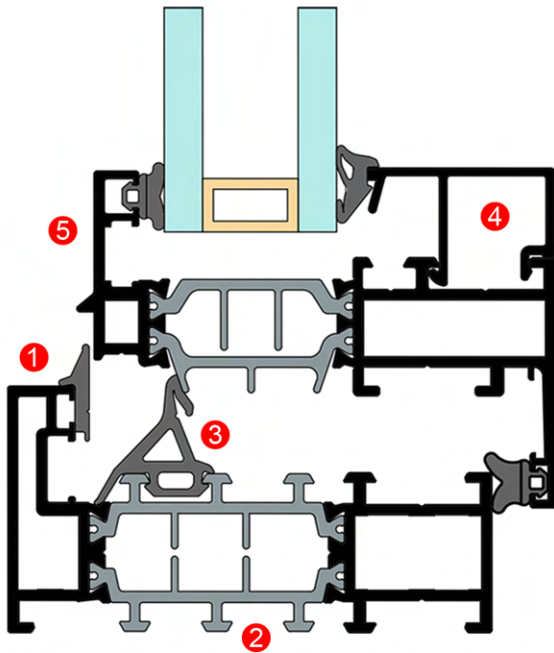

1. Minimal frame dimensions.
2. Large polyamide thermal break.
3. EPDM high performing main gasket seal.
4. Frame depth allows for glass thickness up to 50mm (2").
5. Multiple frame and sash design options.



Modern

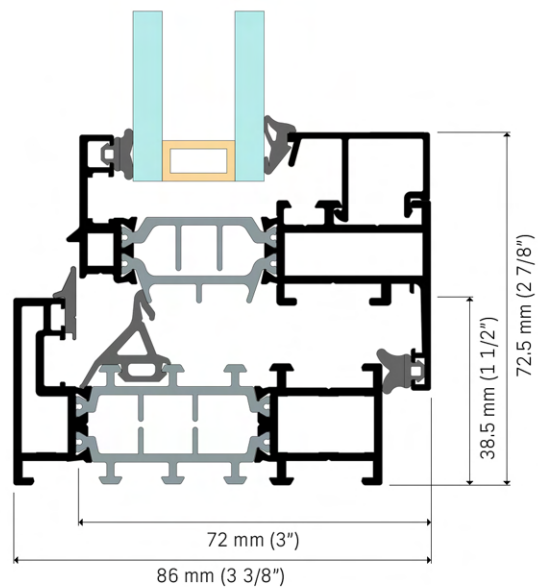
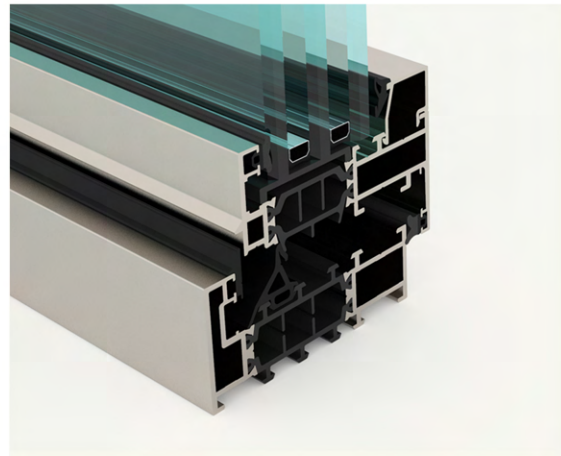

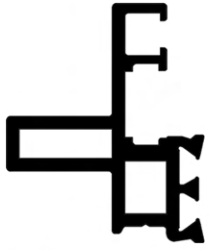

Ferro

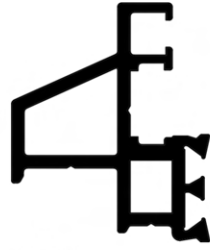

Classic

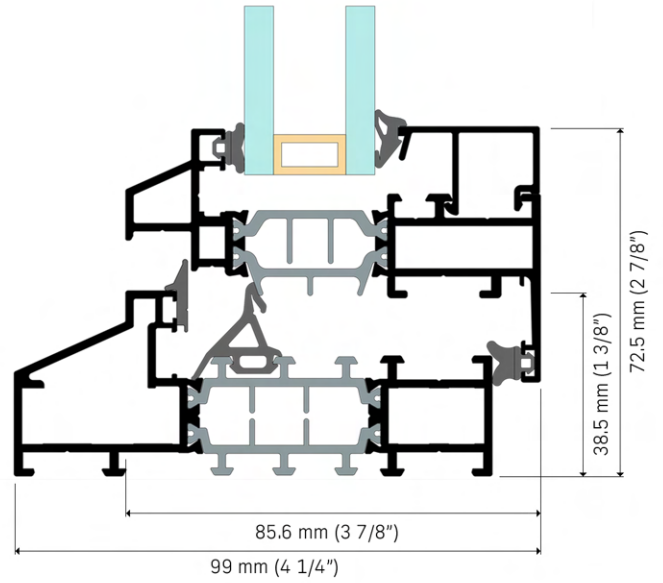
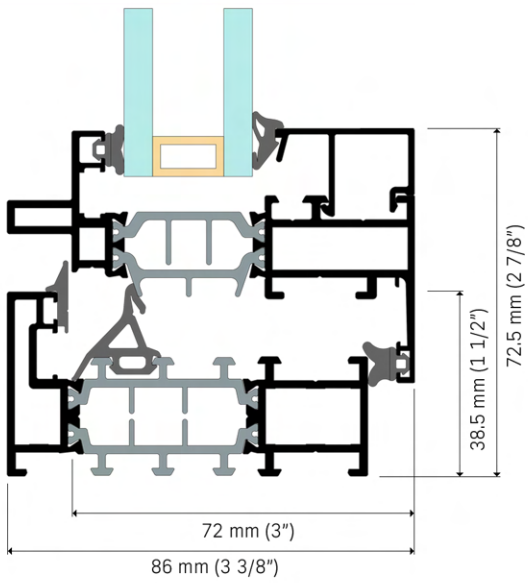
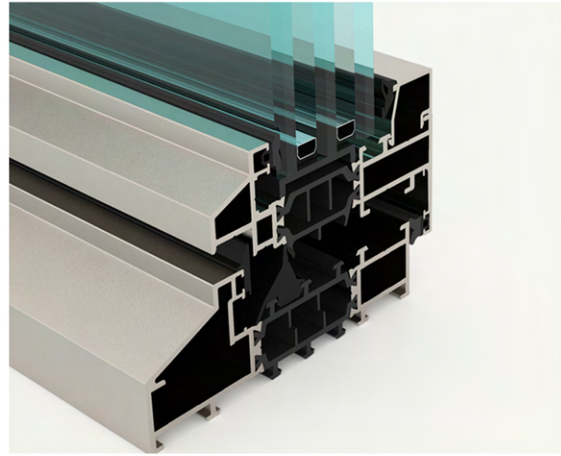
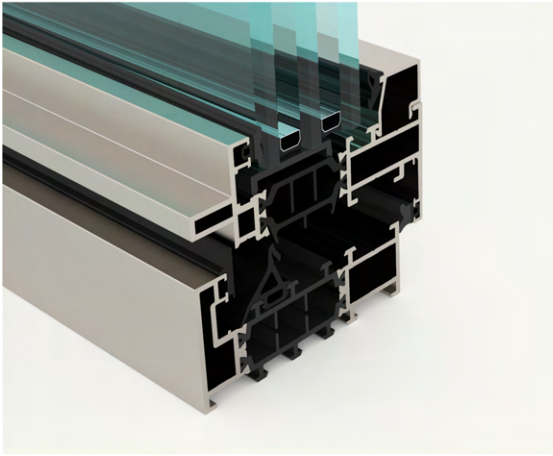

PROJECTS:

Sluice Point



LOCATION: Yarmouth, Nova Scotia
DESIGN: OG Architects



SL 38 Window Options

System & Performance



The SlimLine 38 series feature a highly insulated 3-chamber system with ultra-slim profiles for increased thermal characteristics. The solution is available in fixed, turn, and turn-tilt variations with Uf values down to 2.3 W/m²K (1.9 W/m²K for the HI version). The system is suitable for both double and triple glazing options.

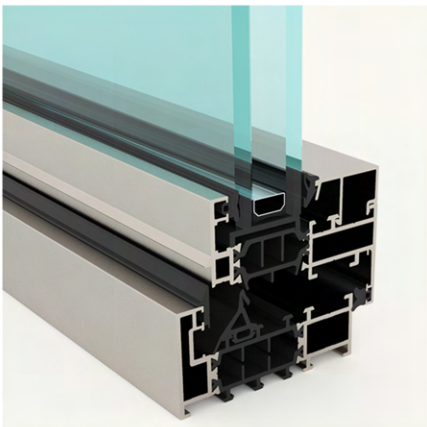

Double glazed unit

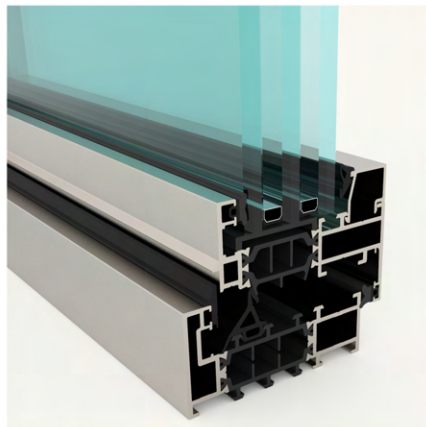

Triple glazed unit

U-factor	0.34	U-factor	0.27
Shgc	0.27	Shgc	0.24
Vt	0.47	Vt	0.41
Condensation Resistance	44	Condensation Resistance	52
Primary Product Designator	class cw - pg90		
Design Pressure	±4320 Pa (±90.23 psf)		
Air Infiltration	0.3 L/s/m ² (0.05 cfm/ft ²)		
Acoustic Performance (with Rw per IGU 45 dB)	up to 48 dB		
Air Infiltration/Exfiltration	A3		
Water penetration resistance test pressure	580 Pa (12.11 psf)		

ref: daw swing door (size tested 1201 x 2432 mm) csa a440s1-09, canadian supplement to AAMA/WDMA/CSA 101/I.S.2/A440 NAFS ref: thermal testing glass sl 38 : sn68 / arg90 / is20 (6mm/6mm) -1" "IG", sl 38-HI : sn68 / arg90 / clr / arg90 / neutral 78/65 (6mm/6mm/6mm) - 2- 1/8" "IG"

Mullions & Transoms

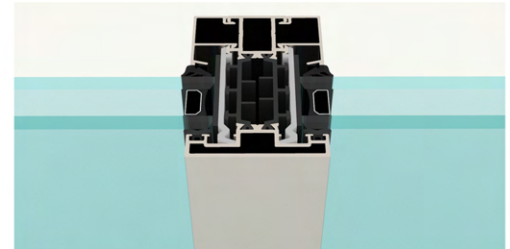

Modern Mullion / Transom

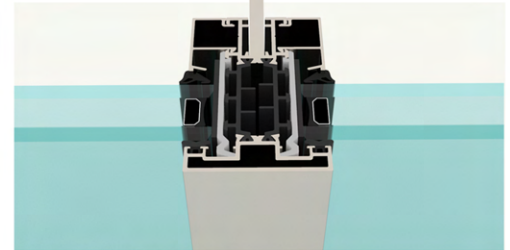

Modern Structural Mullion

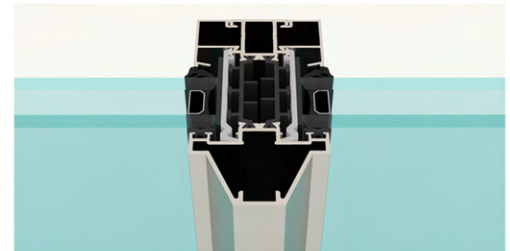

Classic Mullion

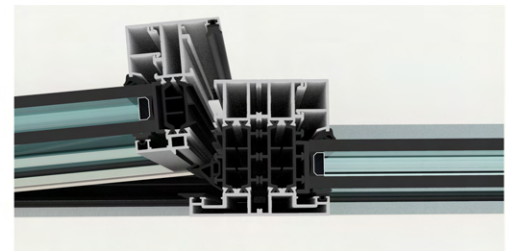

Modern Tilt & Turn to Fixed Mullion

Various mullions and transom designs for aesthetic and structural configurations are available. Flexible mullion designs allow for design freedom. Contact your sales representative for further design details.

Colours

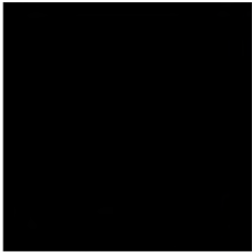

Ral # 9005
Black



Ral # 7021
Black Grey



Ral # 7016
Anthracite Grey



Clear anodized

The SL38 aluminum is available in a wide range of colour options. 160 different RAL colours are available beyond the stock finishes.

Handles



Berlin



Amsterdam



Paris

Handle Colours



Black Matte



Stainless Steel



Bronze *



Copper *



Gold *

* custom, colour consult your representative

SDL

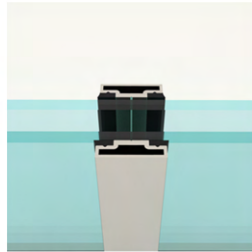

Modern



Ferro

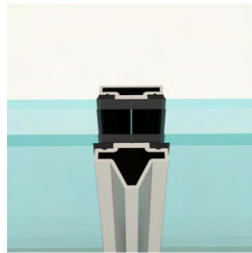

Classic

Various simulated divided light profiles allow for design, flexibility and match the various profiles for a seamless integration of form and function.

Design



Modern



Ferro



Classic

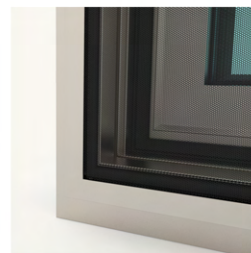

SL38 with insect screen

Modern, ferro and classic looks provide a wide range for design flexibility to match your architectural style.

Flush mounted Insect screens utilize dual neodymium magnet technology for easy removal and attachment.

Hinges



Standard hinge



Concealed hinge

SL 38

Windows & Doors



PHOTOGRAPHER: Nadelbachphoto.com



SL 38 Door Options

System & Performance



SL 38 Swing doors systems integrate seamlessly with the SL38 window product. Inswing or outswing configurations are available in both framed or low threshold options. Integrating dual or triple glazing can allow designers to achieve the thermal performance required to meet today's stringent building code.

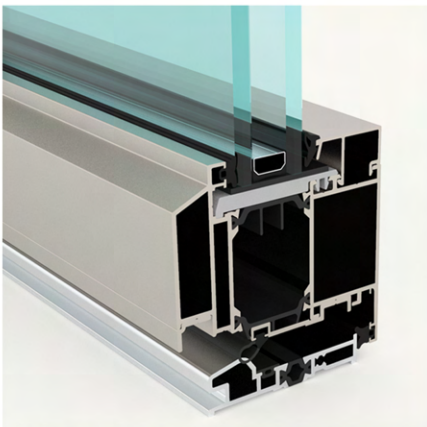

Double glazed unit

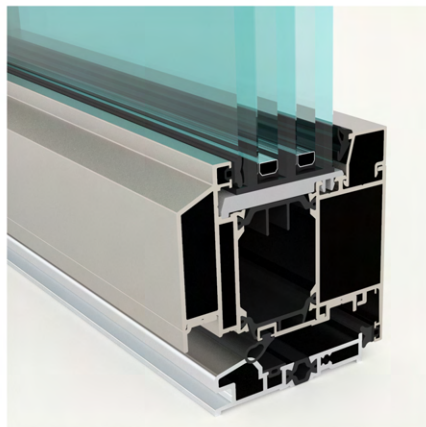

Triple glazed unit

U-factor	0.34	U-factor	0.27
Shgc	0.27	Shgc	0.24
Vt	0.47	Vt	0.41
Condensation Resistance	44	Condensation resistance	52
Primary Product Designator	class cw - pg90		
Design Pressure	±4320 Pa (±90.23 psf)		
Air Infiltration	0.3 L/s/m ² (0.05 cfm/ft ²)		
Acoustic Performance (with Rw per IGU 45 dB)	up to 48 dB		
Air Infiltration/Exfiltration	A3		
Water penetration resistance test pressure	580 Pa (12.11 psf)		

ref: daw swing door (size tested 1201 x 2432 mm) csa a440s1-09, canadian supplement to AAMA/WDMA/CSA 101/I.S.2/A440 NAFS ref: thermal testing glass sl 38 : sn68 / arg90 / is20 (6mm/6mm) -1" IG", sl 38-HI : sn68 / arg90 / clr / arg90 / neutral 78/65 (6mm/6mm/6mm) - 2- 1/8" IG"

Connections & Sill options

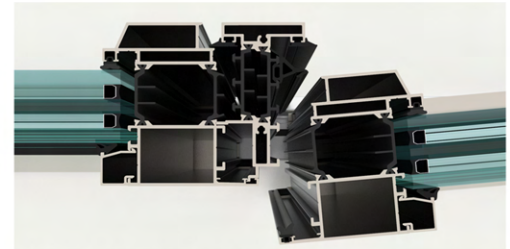

French Door Astragal (open)

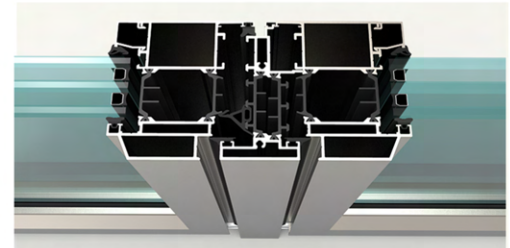

French Door Astragal (closed)

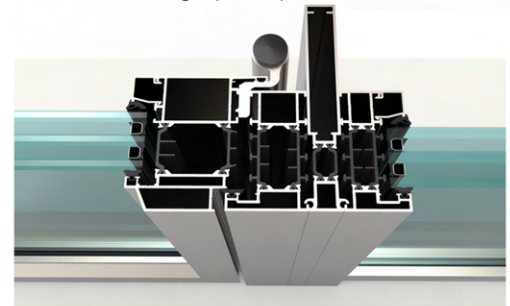

Door to Side light Connection

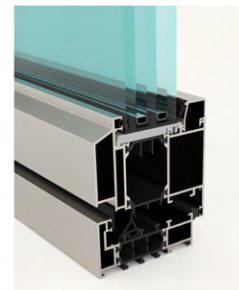

Standard sill option

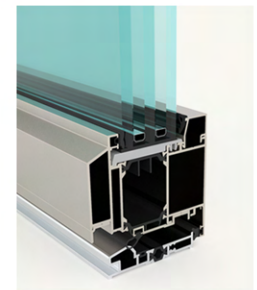

ADA sill option

A high-performance door must have a superior sealing system. Without it, your doors will not provide the necessary energy savings, indoor air quality and interior comfort. For tough climates, such as extremely cold winters, ocean front properties or high-rise buildings, an additional line of defense provides additional protection from air, water and sound. Tiltco's SL 38 door system features a third flexible seal located in the center of the frame. This seal is one continuous seal that is designed to remain in contact under all environmental conditions.

Colour

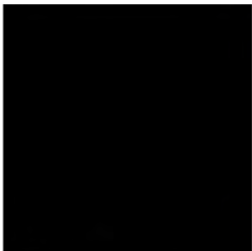

Ral # 9005
Black



Ral # 7021
Black grey

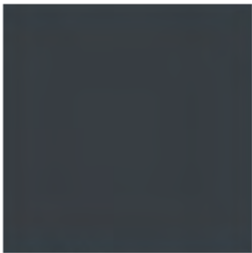

Ral # 7016
Anthracite grey



Clear Anodized

Powder coating is widely considered to be the ideal method for protecting aluminum profiles and parts. By electrostatically spraying and fusing the mixture of pigments and resins onto a surface, you can achieve a high-quality, durable finish that will extend the life of the metal and ensure its continued aesthetics.

for custom colours, consult your sales representative

Handles

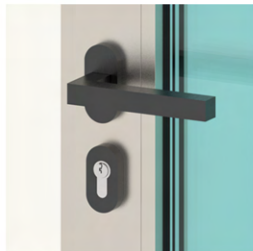

Berlin



Amsterdam



Paris

Handle Colours



Black Matte



Stainless Steel



Bronze *



Copper *



Gold *

* custom colour, consult your representative.

SDL

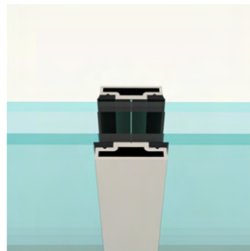

Modern



Ferro



Classic

Various simulated divided light profiles allow for design, flexibility and match the various profiles for a seamless integration of form and function.

Hinges

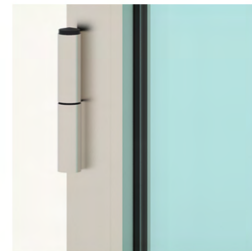

Standard



Concealed hinge

The SL 38 hinge system enables effortless 3D adjustability and elegant contours, in addition to high load capacities and secure pull-out strength. The completely concealed hinge systems from Tiltco, boasts innovative properties which are optimised to meet the requirements of modern architecture.

Configurations

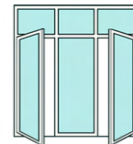
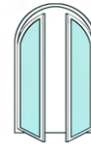
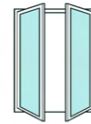
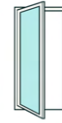

CP 130 LS

System Overview: Lift & Slide

Invite nature in your home. Incorporate the largest openings into your designs.

The robust CP 130 LS allows the construction of large and stable lift-slide panels. Independently tested to provide unparalleled resistance to air, water, structural and thermal performance.

The CP 130 lift-slide door operation allows the door to lift 6mm (1/2") with the turn of a handle and glide smoothly along its guide rails with no friction.

Effortlessly operate sliding panels up to 300 kgs and over 10 feet tall while maintaining overall performance. Available in OX, OXO, OXXO, OXXXXO, 90 degree corner, and pocket solutions.



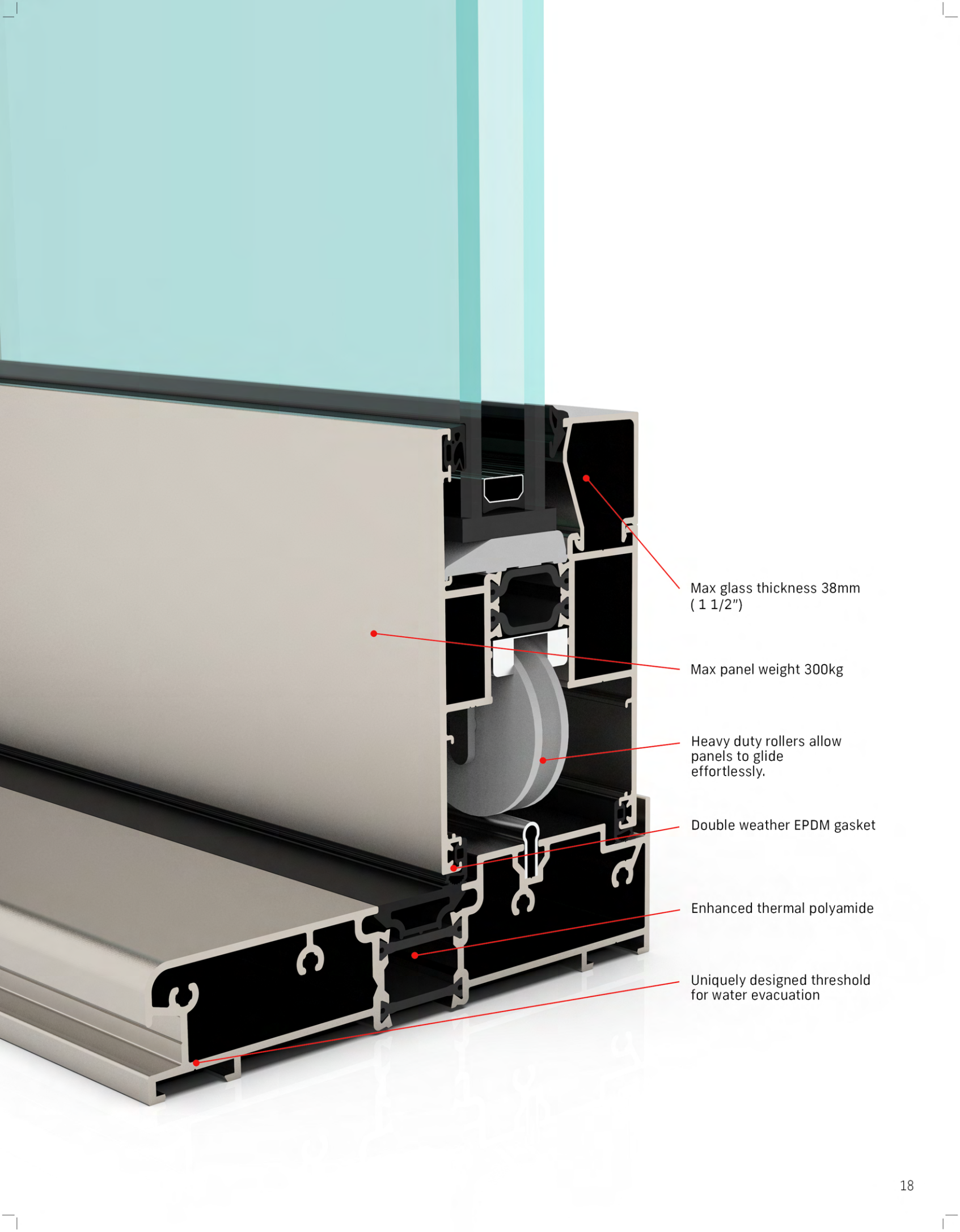

Max glass thickness 38mm
(1 1/2")

Max panel weight 300kg

Heavy duty rollers allow
panels to glide
effortlessly.

Double weather EPDM gasket

Enhanced thermal polyamide

Uniquely designed threshold
for water evacuation

CP 130 LS

Design Features : Lift & Slide

Blur the lines; inside-out living with oversized door design.

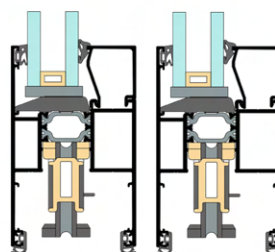

CP 130 LS
2 track configuration

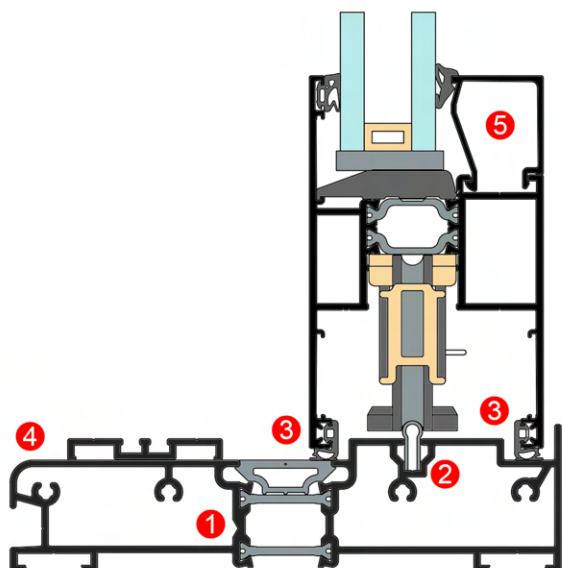
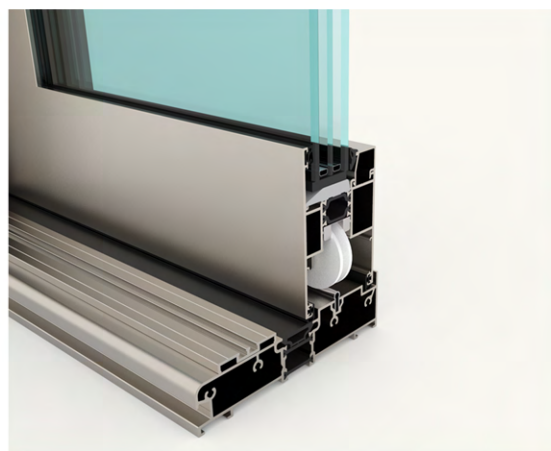

1. Uniquely shaped threshold for water evacuation.
2. Stainless steel rails allow smooth operation.
3. Double weather EPDM gasket allows for maximum weather protection.
4. Robust profile for maximum structural performance.
5. Glazing depth up to 38 mm (1 1/2"), for the highest thermal efficiency.

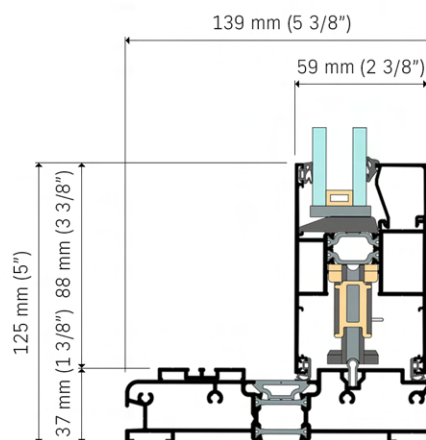

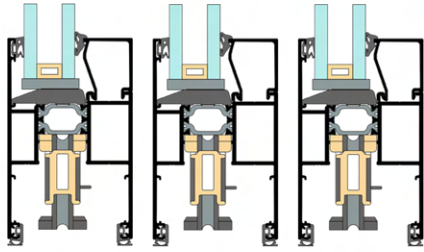

CP 130 LS
3 track configuration

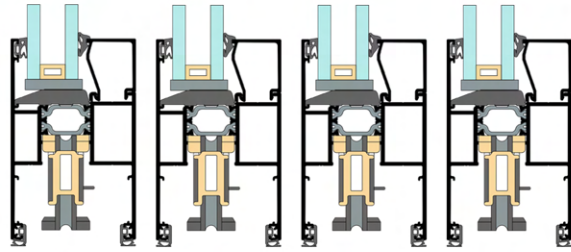

CP 130 LS
4 track configuration

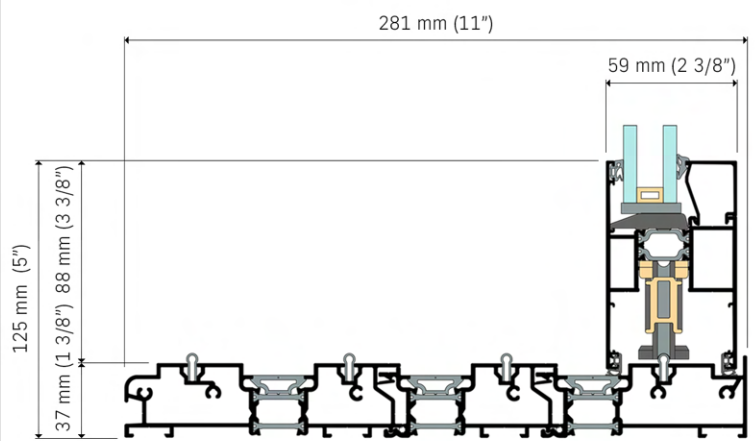
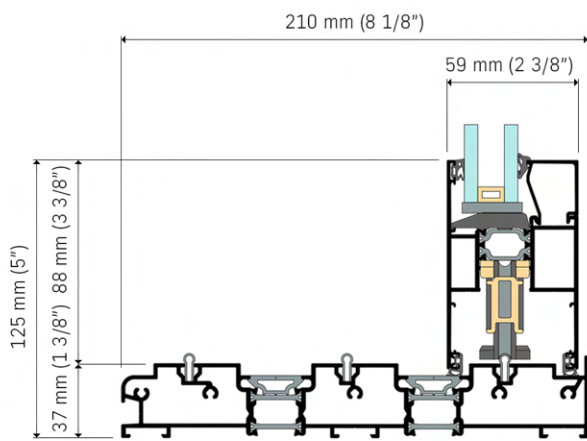
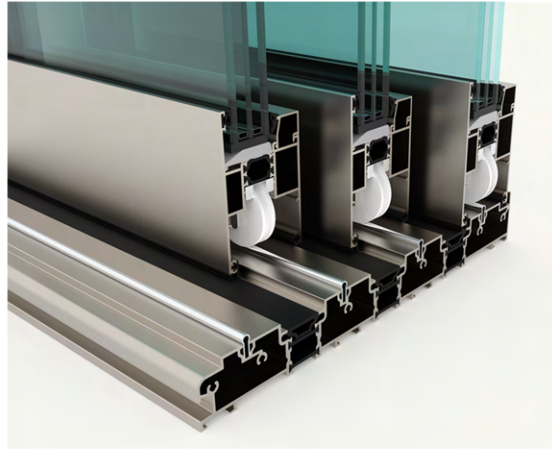
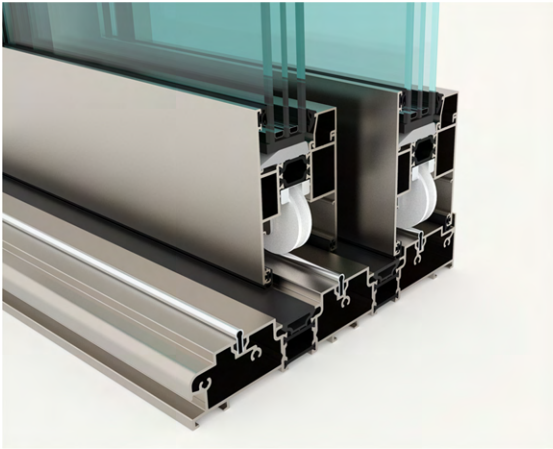

PROJECTS:

A-frame





CP 130 Lift & Slide Options

System and Performance



CP 130 lift and slide system is engineered to allow for construction of large and stable sliding windows and doors with a sliding panel weight up to 300 kg. The CP 130 LS offers extra large openings to offer unobstructed views, seamless indoor-outdoor living, and abundant natural light.

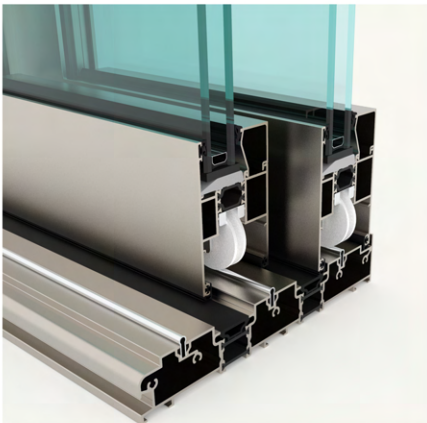

Double glazed unit

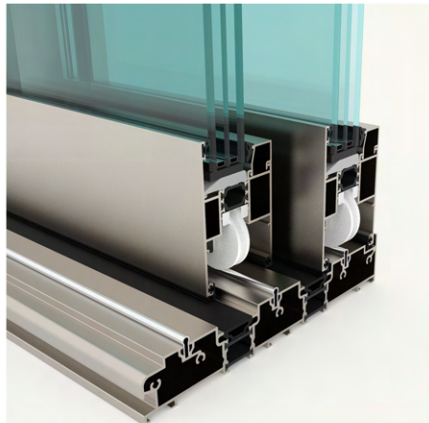

Triple glazed unit

U-factor	0.35	U-factor	0.27
Shgc	0.20	Shgc	0.21
Vt	0.44	Vt	0.36
Condensation Resistance	45	Condensation Resistance	45
Primary Product Designator	class aw - pg40		
Design Pressure	± 1920 Pa (± 40.00 psf)		
Air Infiltration	0.3 L/s/m ² (0.05 cfm/ft ²)		
Acoustic Performance (with Rw per IGU 45 dB)	up to 48 dB		
Air Infiltration/Exfiltration	A2		
Water penetration resistance test pressure	440 Pa (9.00 psf)		

ref: CP 130 LS (size tested 3100 x 2400 mm) Report No: E6385.01-301-01, AAMA/WDMA/CSA 101/I.S.2/ A440 NAFS
 ref: thermal testing glass CP 130 LS : E366 / ARG90 / i89 (6MM/6MM) - 1** IG* , SNX 62/27 / ARG90 / SNX 62/27 / ARG90 / IS-20 (6MM/6MM/6MM)- 1-3/4"

Size and Variations

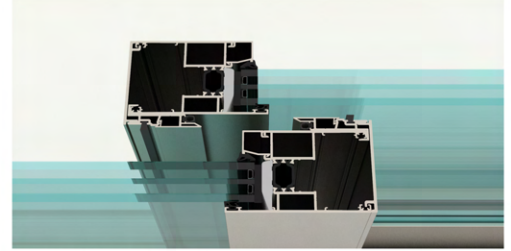

Interlock (Open position)

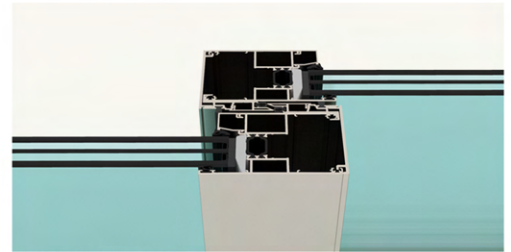

Interlock (Closed position)



Head Section

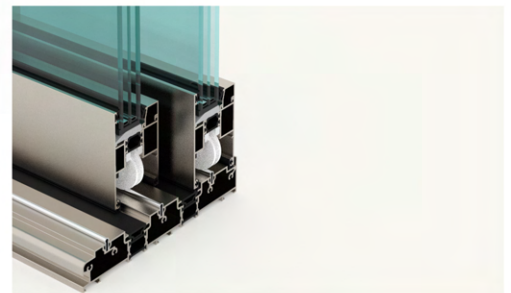

Sill Section

CP 130 LS features advanced operating hardware. A simple turn of the large handle quietly disengages the secure locking mechanism and gently lifts the door 6mm before sliding across its rail. In the closed position, the door descends on its interior profile which provides a high water and wind tightness.

Colour

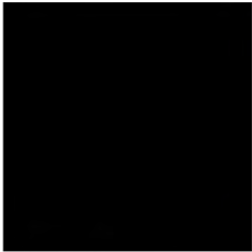

Ral # 9005
Black



Ral # 7021
black grey

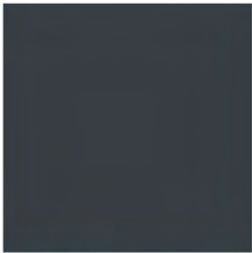

Ral # 7016
Anthracite grey



Clear anodized

The CP 130 LS aluminum is available in a wide range of colour options. 160 different RAL colours are available beyond the stock finishes.

Handles



Berlin



Amsterdam



Exterior Handle

Handle colours



Black Matte



Stainless Steel



Bronze *



Copper *



Gold *

* custom, colour consult your representative

Type

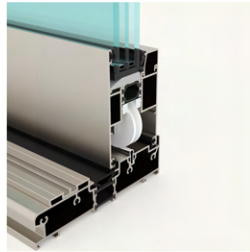

2 Track

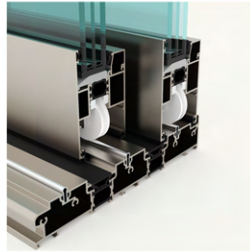

3 Track

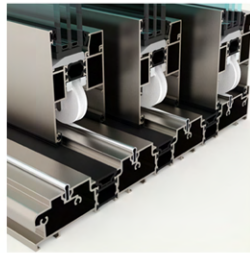

4 Track

Two track, three track or four, the wide range of track options allows for fully customizable panel configurations for extra large openings. Creating a perfect and clear continuity between the indoor and outdoor spaces.

Accessories

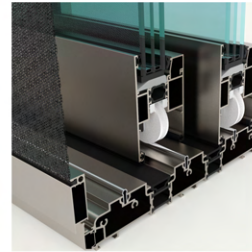

cp 130 ls
3 Track w/ Integrated screen

CP 130 LS screens are durable aluminum framed insect screens that can easily be removed for ease of cleaning and seasonal use.

Configurations

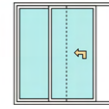

OX

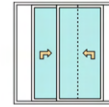

XX

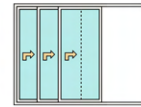

XXX

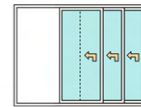

XXX

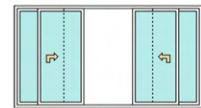

OXXO

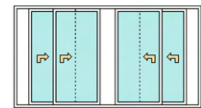

XXXX

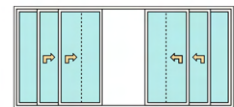

OXXXXO

PROJECTS:





PROJECTS:

Tree Side (Giving Tree) Residence



ARCHITECT: Faulkner Architects
PHOTOGRAPHER: Joe Fletcher Photography



PROJECTS:

Hemlock Point







TILTCO Plant 1 (Show room)
60 Industrial Rd., Bradford,
Ontario, L3Z 3G7

TILTCO Plant 2
60 Industrial Rd., Bradford,
Ontario, L3Z 3G7

P. 905.853.9955
F. 905.853.9905
E. Info@tiltco.com
www.tiltco.com